

Write your name here

Surname

Other names

**Pearson Edexcel
International GCSE**

Centre Number

--	--	--	--	--	--

Candidate Number

--	--	--	--	--

Mathematics B

Paper 1R



Wednesday 14 May 2014 – Morning
Time: 1 hour 30 minutes

Paper Reference

4MB0/01R

You must have: Ruler graduated in centimetres and millimetres, protractor, compasses, pen, HB pencil, eraser, calculator. Tracing paper may be used.

Total Marks

Instructions

- Use **black** ink or ball-point pen.
- **Fill in the boxes** at the top of this page with your name, centre number and candidate number.
- Answer **all** questions.
- Answer the questions in the spaces provided – *there may be more space than you need.*
- **Calculators may be used.**

Information

- The total mark for this paper is 100.
- The marks for **each** question are shown in brackets – *use this as a guide as to how much time to spend on each question.*

Advice

- Read each question carefully before you start to answer it.
- Check your answers if you have time at the end.
- Without sufficient working, correct answers may be awarded no marks.

Turn over ►

P43032A

©2014 Pearson Education Ltd.

1/1/1/1/



PEARSON

Answer ALL TWENTY-NINE questions.

Write your answers in the spaces provided.

You must write down all stages in your working.

1

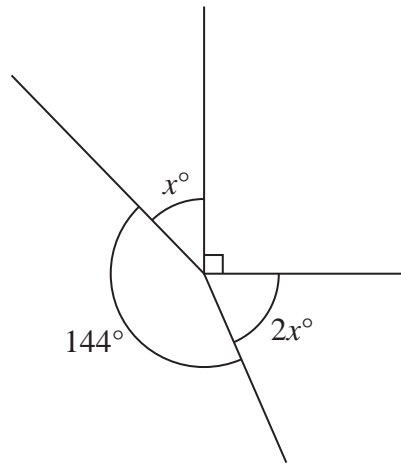

Diagram NOT
accurately drawn

In the diagram, the four straight lines meet at a point. Find the value of x .

$x = \dots\dots\dots$

(Total for Question 1 is 2 marks)

2 Find $33\frac{1}{3}\%$ of £37.92

£ $\dots\dots\dots$

(Total for Question 2 is 2 marks)



3

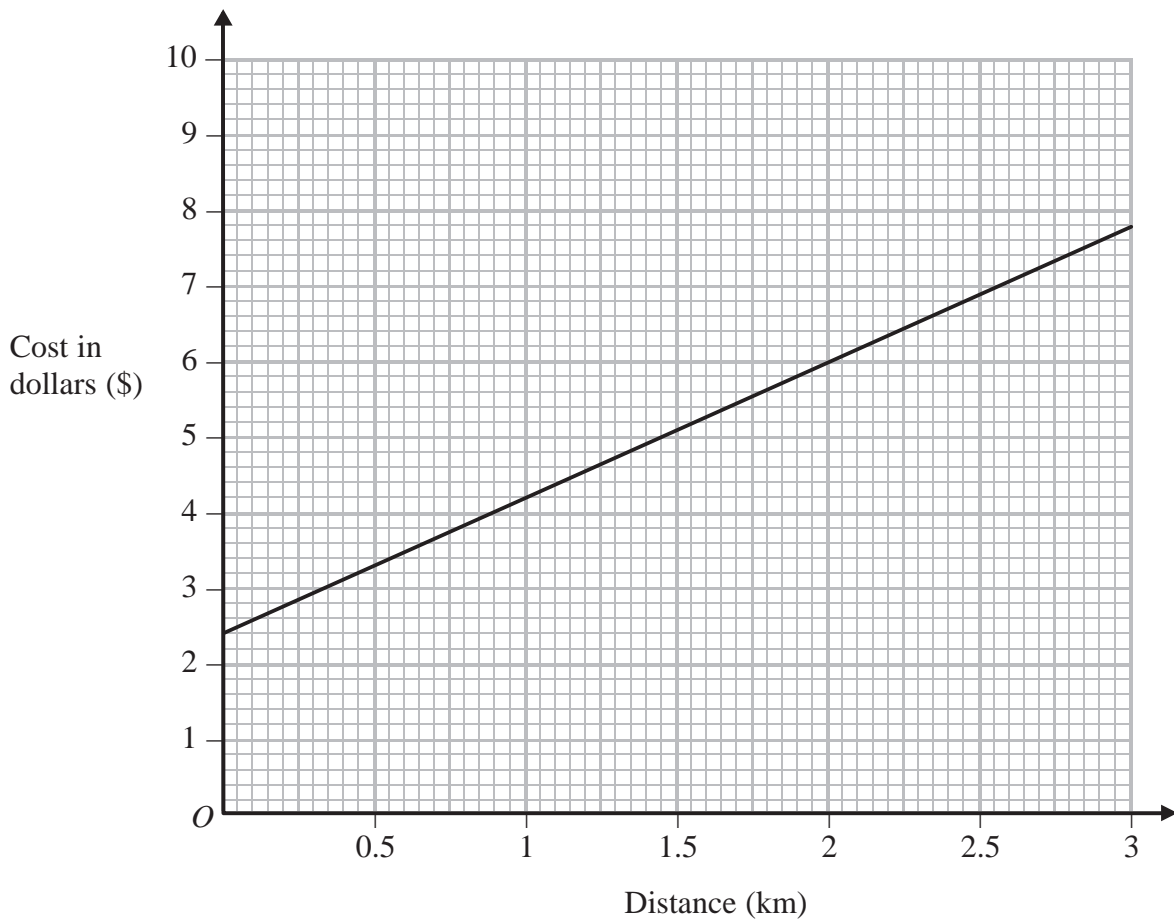

The graph gives information about the costs of taxi journeys of different distances. The cost of a taxi journey consists of a fixed initial charge and a charge per km. From the diagram write down

(a) the fixed initial charge,

\$ (1)

(b) the charge per km.

\$ (1)

(Total for Question 3 is 2 marks)



4 Simplify fully $\frac{3x}{2} \div \frac{9x}{4(x+2)}$

(Total for Question 4 is 2 marks)

5 Draw accurately the locus of all the points that are 2 cm from the line segment AB .



(Total for Question 5 is 2 marks)

6 Factorise completely $3x^2 - 12y^2$

(Total for Question 6 is 2 marks)



7 Showing all your working, express $\sqrt{2} + \sqrt{18}$ in the form $a\sqrt{2}$ where a is an integer.

Write down the value of a .

$a = \dots\dots\dots$

(Total for Question 7 is 2 marks)

8 $\mathbf{A} = \begin{pmatrix} 4 \\ -3 \end{pmatrix}$ and $\mathbf{B} = (3 \ -1)$

Find the matrix product \mathbf{AB}

(Total for Question 8 is 2 marks)

9 Find $\frac{dy}{dx}$ where $y = x^2 + \frac{6}{x}$

$\frac{dy}{dx} = \dots\dots\dots$

(Total for Question 9 is 2 marks)



10 1050 Chinese yuan (¥) is to be divided between three people in the ratios 3 : 5 : 7

Find the difference, in ¥, between the largest share and the smallest share.

¥ =

(Total for Question 10 is 3 marks)

11 Simplify fully $\frac{48x^4y^2}{16x^2y^{-3}}$

(Total for Question 11 is 3 marks)



- 12** The height of a right circular cylinder is four times the radius of the base of the cylinder.
The volume of the cylinder is $500\pi \text{ cm}^3$.

Calculate, in cm, the radius of the base of the cylinder.

..... cm

(Total for Question 12 is 3 marks)

13 Solve $\frac{x}{3} - \frac{x+2}{5} = \frac{x-2}{6}$

$x =$

(Total for Question 13 is 3 marks)



14 The angle of a sector of a circle of radius 12 cm is 85°

Calculate, in cm^2 to 3 significant figures, the area of the sector.

..... cm^2

(Total for Question 14 is 3 marks)

15 Expand and simplify $(x - y)(y + z) - (x + y)(y - z)$

(Total for Question 15 is 3 marks)



16 Find the smallest integer value of x such that $28 - 3x \leq 5(x - 3)$

(Total for Question 16 is 3 marks)

17

Diagram NOT accurately drawn

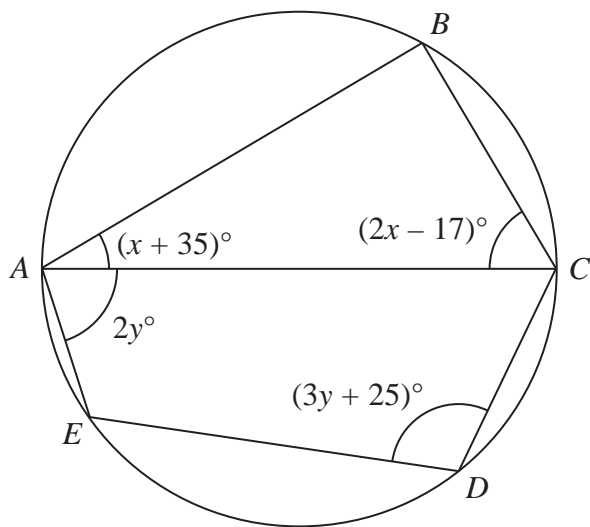

$ABCDE$ is a circle with diameter AC .

$\angle BAC = (x + 35)^\circ$ and $\angle BCA = (2x - 17)^\circ$

(a) Find the value of x .

$x = \dots\dots\dots$
(2)

$\angle CAE = 2y^\circ$ and $\angle CDE = (3y + 25)^\circ$

(b) Find the value of y .

$y = \dots\dots\dots$
(2)

(Total for Question 17 is 4 marks)



- 18** The point A has coordinates $(3, -4)$
The point B is the reflection of the point A in the line $y = -x$

(a) Find the coordinates of the point B .

B (.....,.....)
(2)

The point C is such that $\vec{AC} = \begin{pmatrix} -5 \\ 7 \end{pmatrix}$

(b) Find the coordinates of the point C .

C (.....,.....)
(2)

(Total for Question 18 is 4 marks)

- 19** Here is a list of eight whole numbers.

8 19 14 15 23 6 4 x

The median of these eight numbers is 12

(a) Find the value of x .

$x =$
(2)

(b) Calculate the mean of the eight numbers.

.....
(2)

(Total for Question 19 is 4 marks)

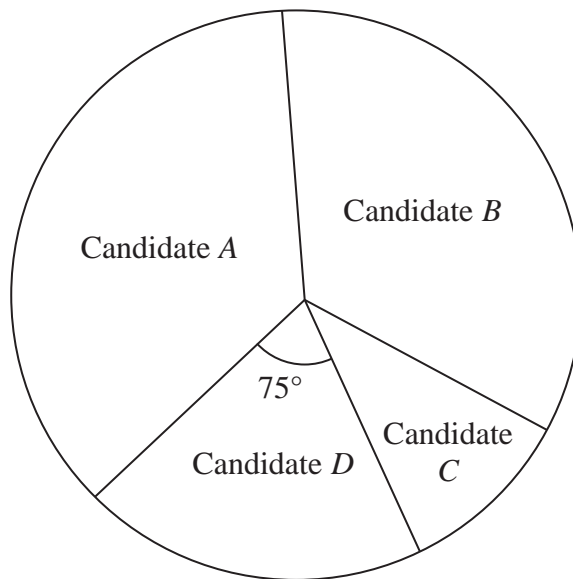

20

Diagram **NOT**
accurately drawn

In the town of *Electoria*, four candidates stood in the election for town mayor. The number of votes each candidate received is represented by the pie chart.

The number of votes Candidate *D* received is 3075 and the angle of the sector for Candidate *D* is 75°

(a) Calculate the total number of votes received by all four candidates.

.....
(2)

Candidate *A* won the election. The angle of the sector for Candidate *A* is 5° greater than the angle of the sector for Candidate *B*.

(b) Calculate how many more votes Candidate *A* received than Candidate *B*.

.....
(2)

(Total for Question 20 is 4 marks)



21 Given that $x = \frac{av + b}{v}$
 express v in terms of a , x and b .

$v = \dots\dots\dots$

(Total for Question 21 is 4 marks)

22

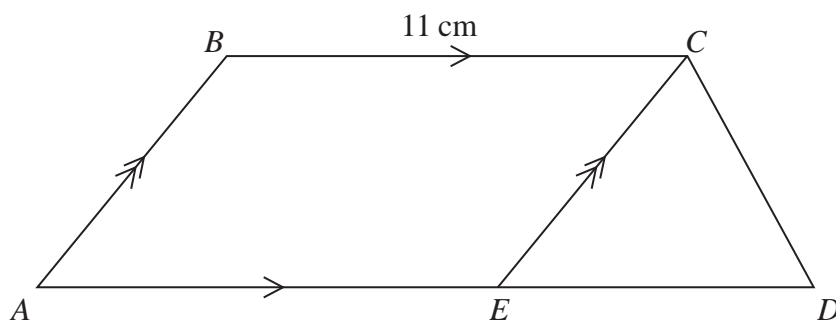

Diagram NOT accurately drawn

$ABCD$ is a trapezium with $BC = 11$ cm, $AD = 15$ cm and BC parallel to AD .
 The point E on AD is such that EC is parallel to AB .
 The area of $\triangle ECD = 7$ cm².

Find the area, in cm², of the trapezium $ABCD$.

$\dots\dots\dots$ cm²

(Total for Question 22 is 4 marks)



23 y varies as the cube of x , and $y = 48$ when $x = 4$

Find x when $y = 162$

$x = \dots\dots\dots$

(Total for Question 23 is 4 marks)

24 $\mathcal{E} = \{ 1, 2, 3, 4, 5, 6, 7, 8, 9, 10 \}$

$A = \{ \text{multiples of } 3 \}$

$B = \{ \text{odd numbers} \}$

$C = \{ \text{factors of } 24 \}$

Complete the Venn diagram by putting each element of \mathcal{E} in the correct subset of \mathcal{E} .

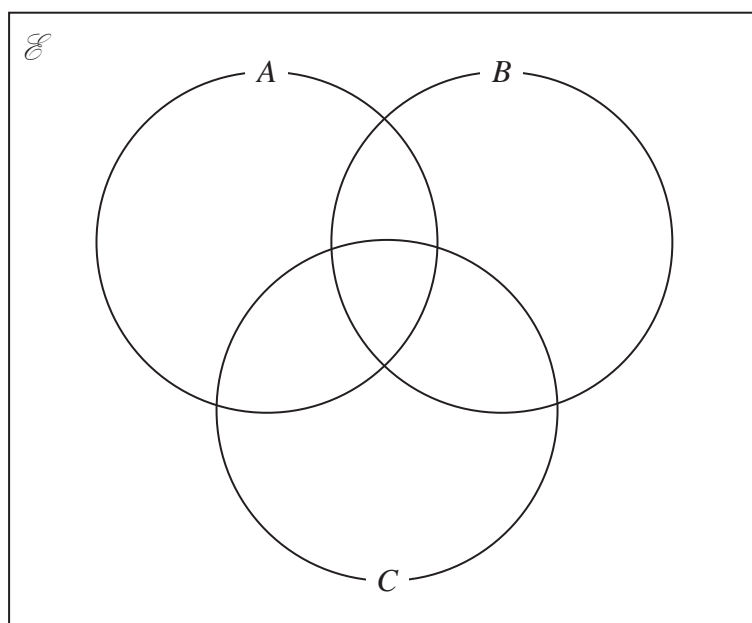

(Total for Question 24 is 5 marks)



25 The *Trumpton Express* is due to arrive at *Feather Green* station every day at 10:00 am. The stationmaster records the arrival times for 120 days. No train arrives more than 4 minutes early or 10 minutes or more late.

The incomplete table and histogram give information about the arrival times.

Using this information, complete the table and the histogram.

Arrival time (t)	Frequency
$9:56 \leq t < 10:00$	16
$10:00 \leq t < 10:01$	14
$10:01 \leq t < 10:02$	
$10:02 \leq t < 10:05$	
$10:05 \leq t < 10:10$	

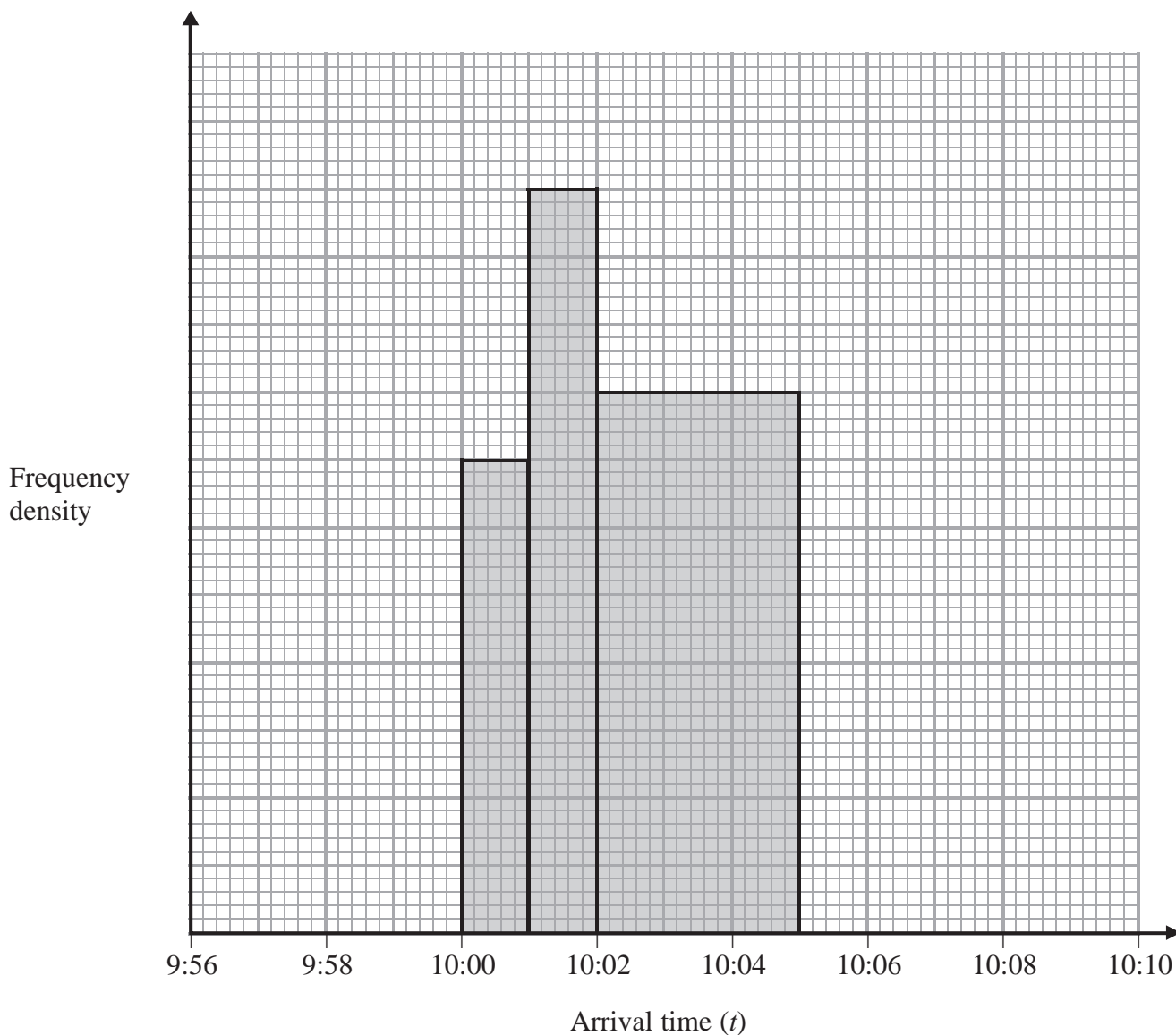

(Total for Question 25 is 5 marks)



26

Diagram NOT accurately drawn

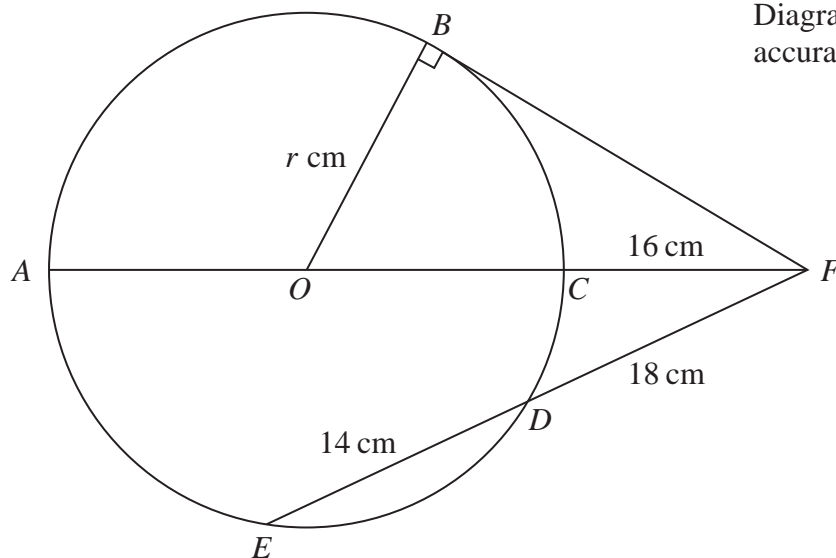

$ABCDE$ is a circle centre O . The diameter, AC , is extended to the point F so that $CF = 16$ cm. The line BF is the tangent to the circle at B and FDE is a straight line such that $FD = 18$ cm and $DE = 14$ cm. The radius of the circle is r cm.

Calculate

(a) the length, in cm, of FB ,

$FB = \dots\dots\dots$ cm
(2)

(b) the value of r .

$r = \dots\dots\dots$
(3)

(Total for Question 26 is 5 marks)



27 (a) Show that $(x - 1)$ is a factor of $6x^3 + 7x^2 - 18x + 5$

(2)

(b) Hence, or otherwise, completely factorise $6x^3 + 7x^2 - 18x + 5$

.....
(3)

(Total for Question 27 is 5 marks)



28

Diagram NOT accurately drawn

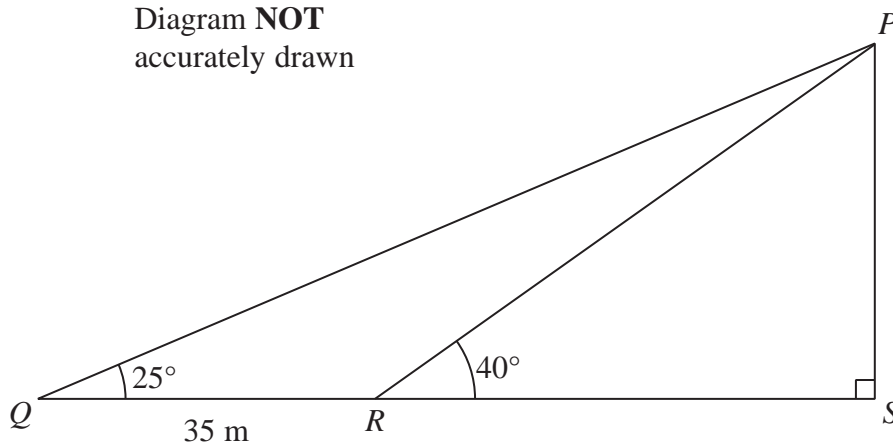

The points Q , R and S lie in a straight line on horizontal ground with $QR = 35$ m. The vertical mast PS is such that $\angle PQR = 25^\circ$ and $\angle PRS = 40^\circ$

(a) Write down the size, in degrees, of $\angle QPR$.

$$\angle QPR = \dots\dots\dots^\circ$$

(1)

(b) Calculate the length, in m to 3 significant figures, of PR .

$$PR = \dots\dots\dots \text{ m}$$

(3)

(c) Calculate the height, in m to 3 significant figures, of the mast PS .

$$PS = \dots\dots\dots \text{ m}$$

(2)

(Total for Question 28 is 6 marks)



- 29 A particle P is moving along a straight line. The displacement, s metres, of P from a fixed point O on the line at time t seconds is given by

$$s = 4 + 12t - t^3 \quad t \geq 0$$

- (a) Write down the distance, in m, of the particle from O at time $t = 0$

..... m
(1)

Particle P comes to instantaneous rest at the point A .

- (b) Find the value of t when P is at A .

$t =$
(4)

- (c) Find the acceleration, in m/s^2 , of P when P is at A .

..... m/s^2
(2)

(Total for Question 29 is 7 marks)

TOTAL FOR PAPER IS 100 MARKS



BLANK PAGE



BLANK PAGE

